

This activity book  
belongs to:

---

# ACTIVITY BOOK

MELTON LEVEL CROSSING REMOVAL PROJECT

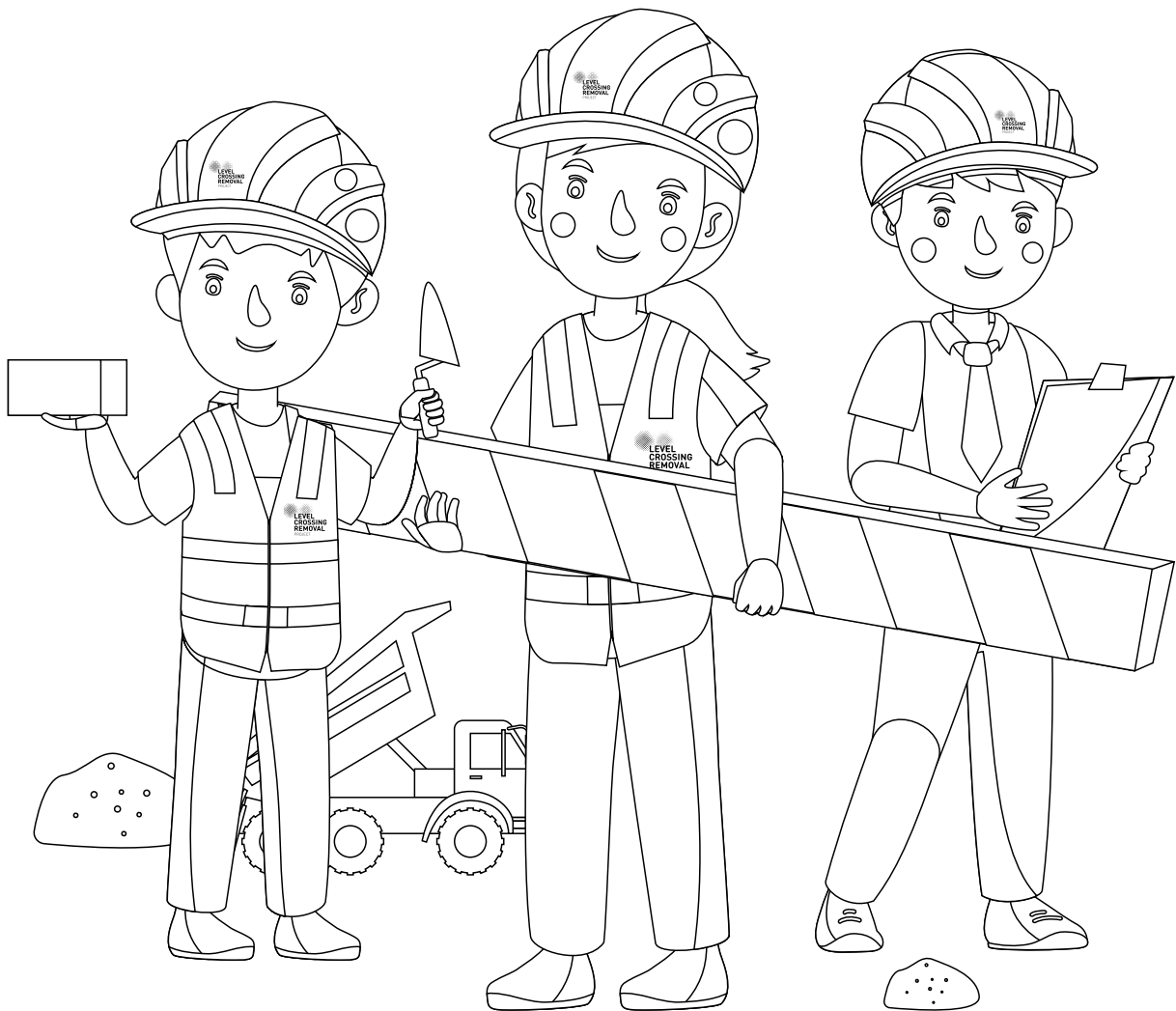

# Colour me in, then play me!

It's like 'Snakes and Ladders' but it's called 'Boom Gates and Train Tracks'!  
Read below and find out how to play.

## Instructions

1. Each player starts at the number one square. Use something from your home or your pocket as a playing piece.
2. Take turns to roll the dice (See page 3 for a dice you can make yourself!) and move your playing piece forward the number of spaces shown on the dice.
3. If your playing piece lands on the bottom of the track, move to the top of the track.
4. If your playing piece lands on the top of the boom gate, move to the bottom of the boom gate.
5. The first player to get to the space that says 'end' is the winner!

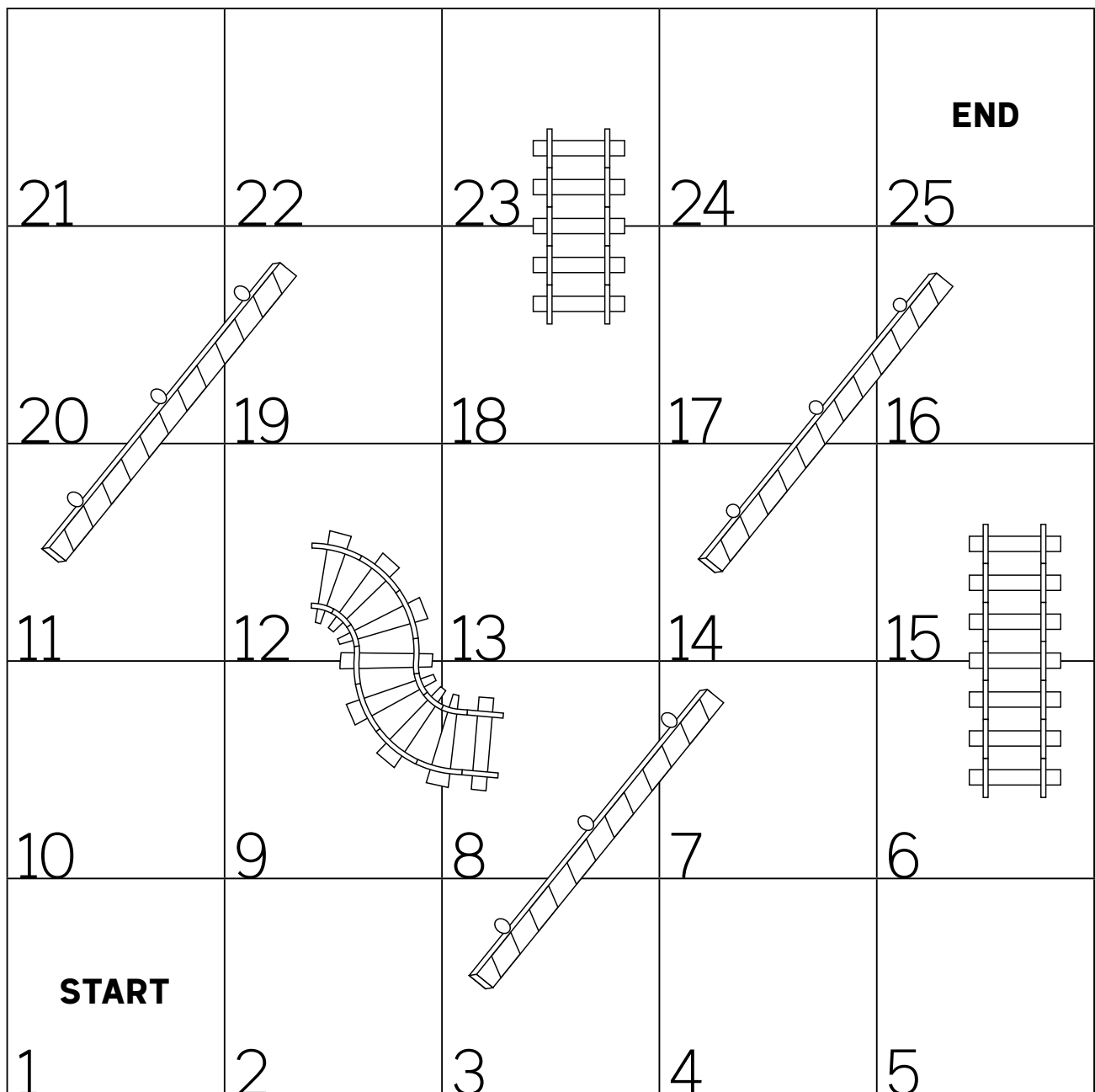

# Colour me in, cut me out, then play me!

## Instructions

1. Colour me in!
2. Cut around the outside of the shape.  
Note: You might need an adult to help you do this!
3. Once you have cut out your dice you need to fold along the dashed inside lines and tabs.
4. Then put some glue on the tabs and push them against the opposite side.
5. Assemble your dice by gluing the rest of the faces along the tabs to form your cube!
6. You can now use me for the game on page 1!

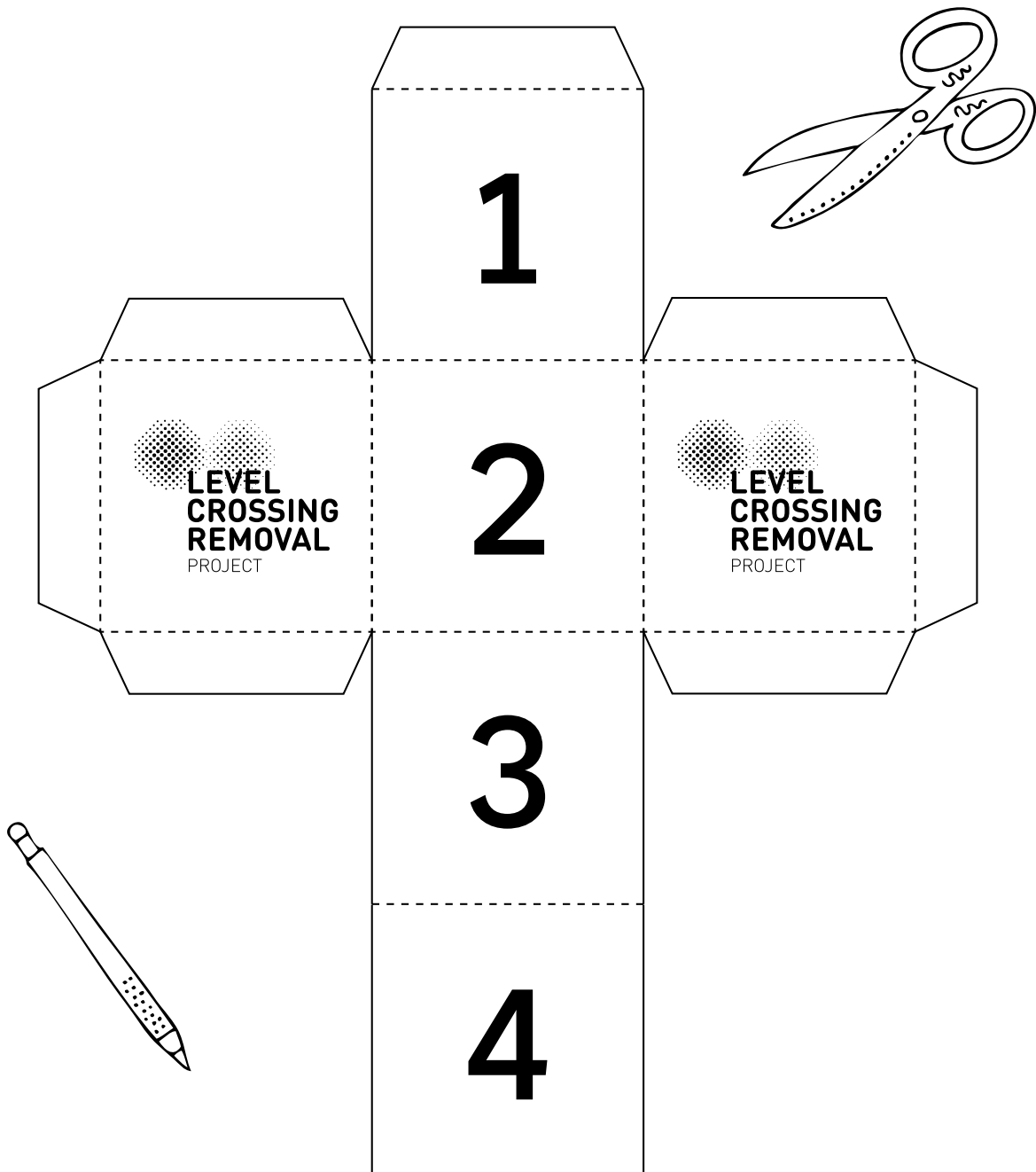

# Colour me in, and

There are lots of different kinds of construction vehicles, and each one has its own job! Here are a few you can find on the level crossing removal sites.

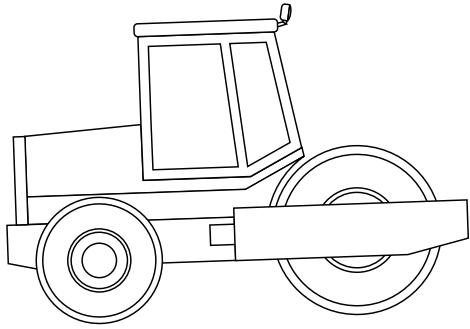

Road Roller

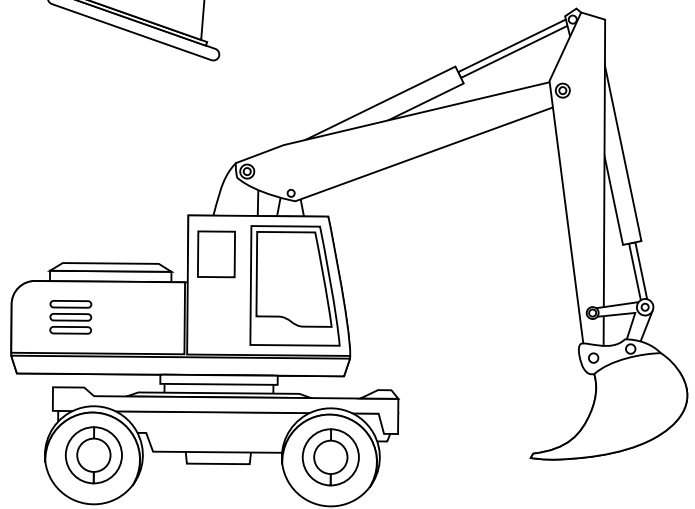
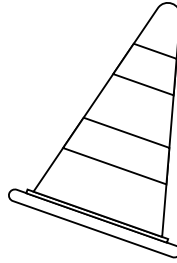

Excavator

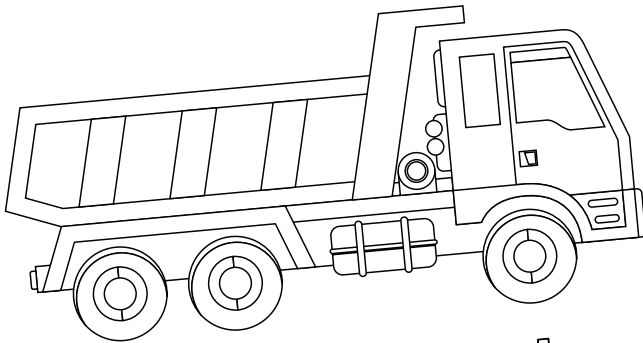

Dump Truck

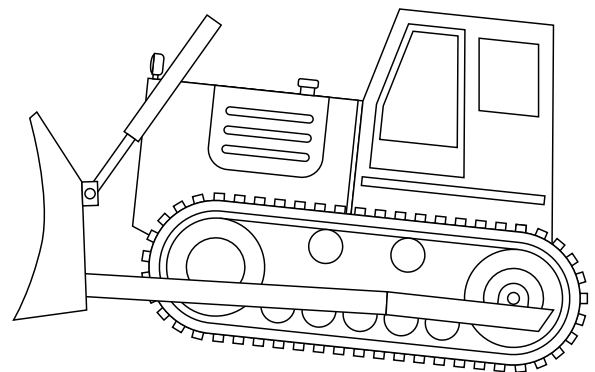
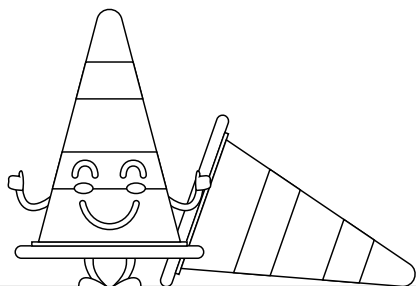

Bulldozer

# Help the truck through the maze!

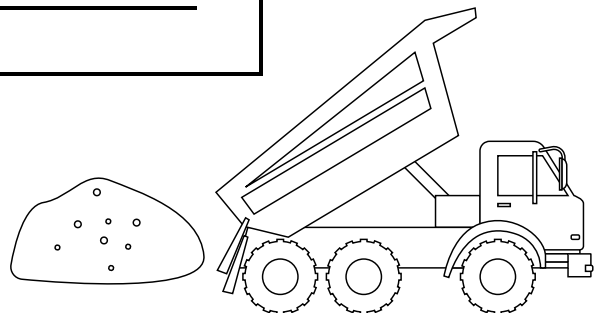
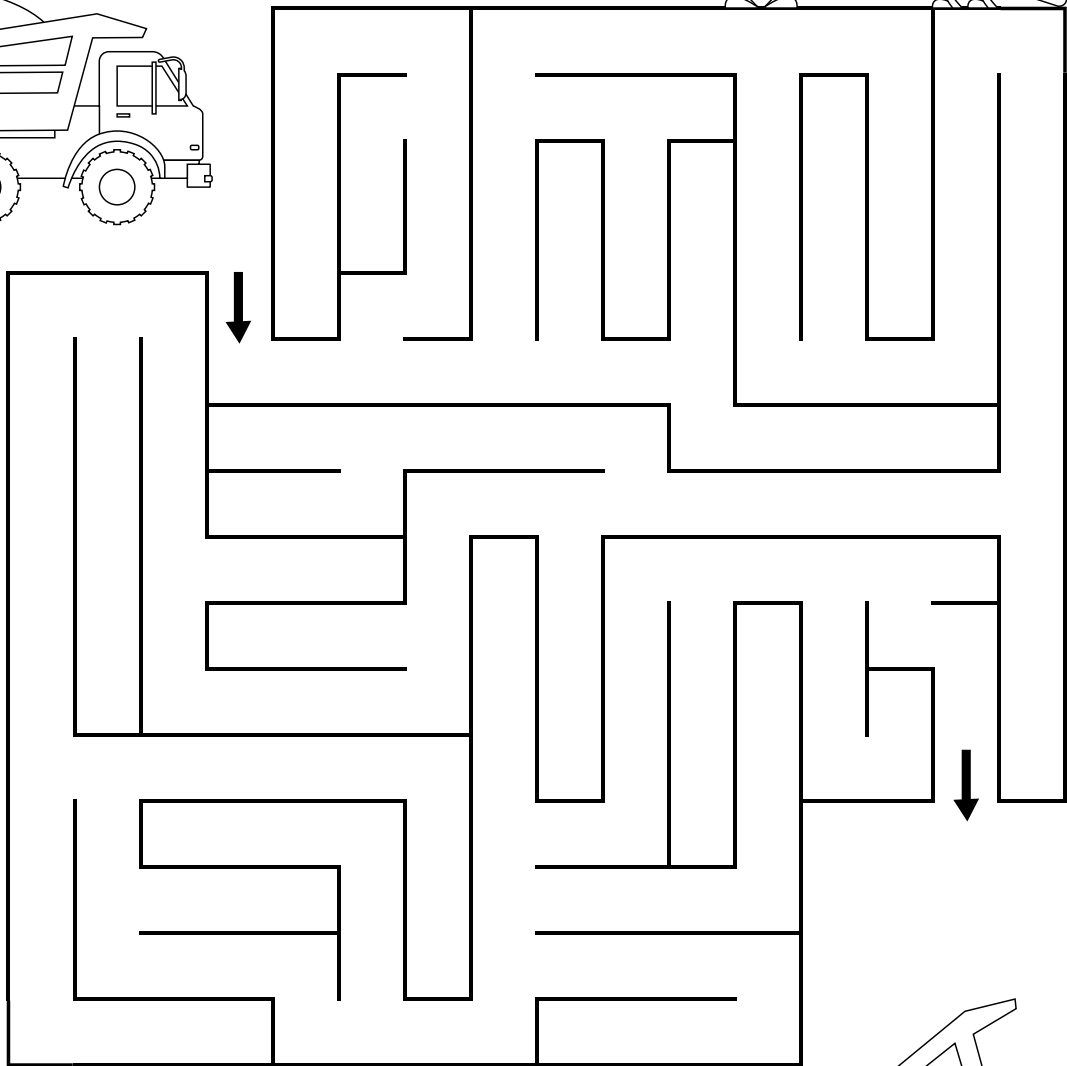
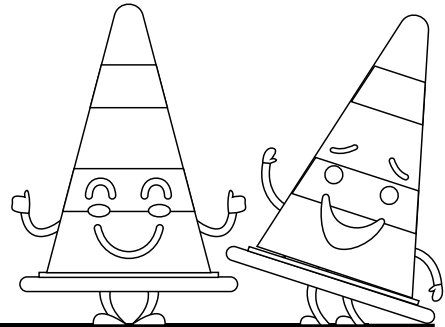
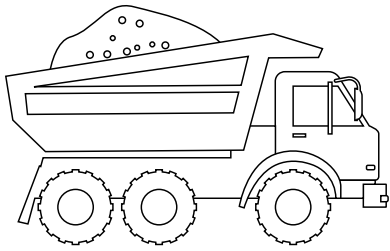

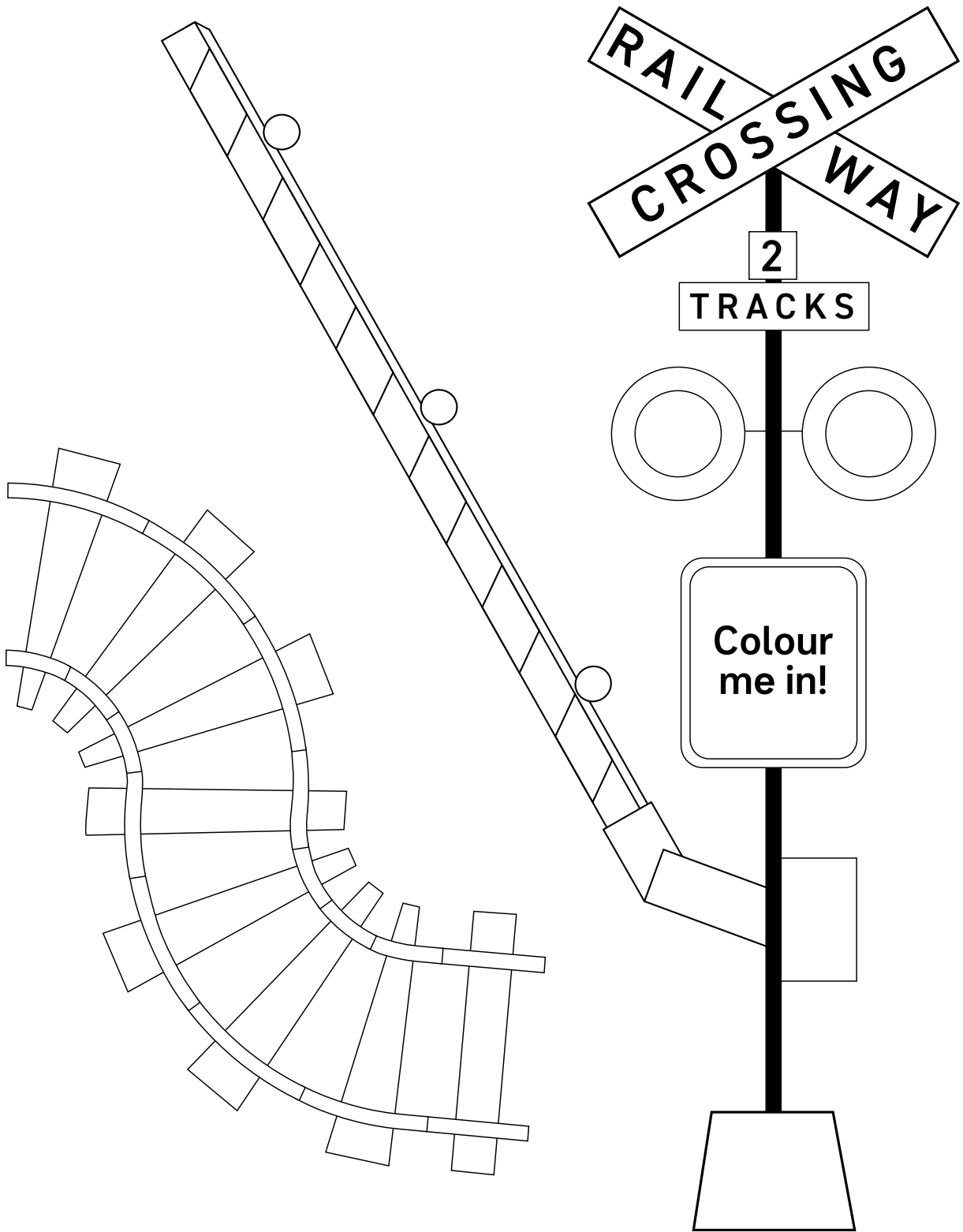

# Spot the difference!

It takes lots of different types machinery and construction techniques to remove the four level crossings and build the new Melton Station, much like there are some differences in the illustrations below.

Look carefully, can you spot all 10?

A



B



6. Missing steps
7. Missing indent
8. Flipped trowel blade
9. Missing ear cavity
10. Purple sticker

1. Missing brick perforation
2. Closed eyes
3. Flipped nose
4. Missing stones
5. Missing small rock